



VINCENT TRIM ONLY FOR 3/4" VOLUME CONTROL AND 4-PORT DEDICATED DIVERTER

Vincent

A4012LV(finish)TO

FEATURES

- Trim set with escutcheon, dome and handle only to:
 - A4911BO rough
 - R1040R rough
 - R1062BO rough
- All components made of brass
- **Must order rough to complete**

COLORS/FINISHES

- Polished Chrome
- Polished Nickel
- Satin Nickel

WARRANTY

- Limited Lifetime

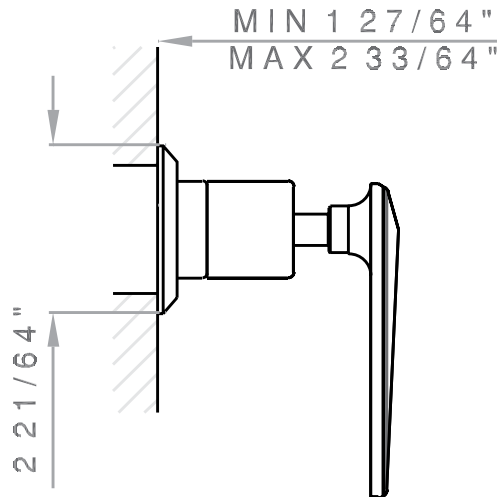

INSTALLATION INSTRUCTIONS

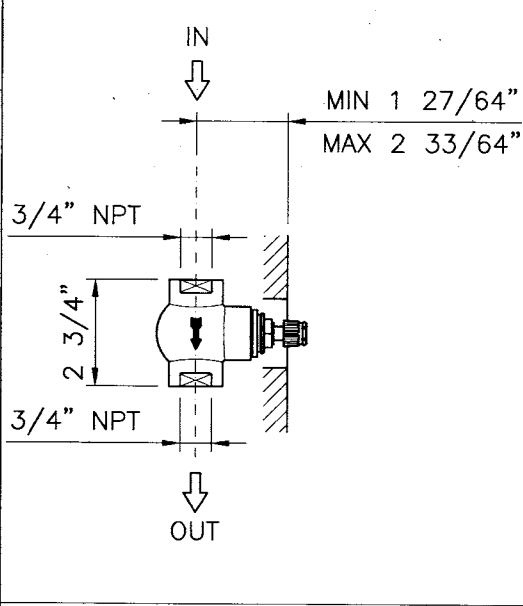
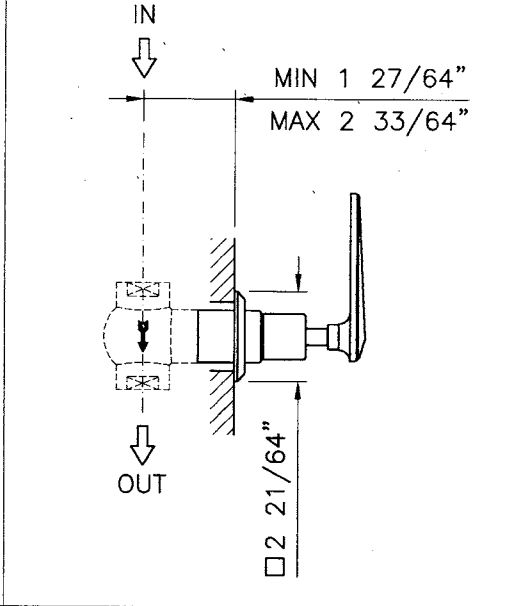
<p>Volume control inside part Art. A4911BO</p> 	<p>Volume control external part Art. A4012LV--</p> 
<p>Preliminary information</p> <ol style="list-style-type: none"> 1. The A4911BO and A4912 trim kit are separate units. You must order both to complete the package. 2. The A4911BO has the adaptor C7594 in the box 3. The A4911BO is port specific. Make sure the arrow points in the direction of the flow. 4. 1 1/2" extension kit C4912 is available. Must order separately. 	
<p>a - Preparation</p> <ol style="list-style-type: none"> 1. Flush the system before and after installation. 	
<p>b - Assembly of inside body</p> <ol style="list-style-type: none"> 1. Estimate the finished wall and install the rough at the required depth. 2. Make sure the arrow on the body point in the direction of the flow. 3. DO NOT SOLDER THE CONNECTIONS: Heating the valve will damage the cartridge. <u>There is no warranty on cartridges damaged by heat.</u> 4. Leave the plastic mudguard in place if further work is done in the area. 	

INSTALLATION INSTRUCTIONS

c - Assembly of external part

Please note: The trim kit is assembled out of the box. There are no parts assembled. Parts 2 through 12 are preassembled (except part 5).

1. Remove the mudguard.
2. Confirm the installation of adaptor C7594.
3. Position the lever at 12 o'clock and screw the body #3 on to the rough valve #1 with the adaptor C7594 in place. Please note: Part #2 is a part of the assembly and not an extension. The extension kit is number C4912 and is not part of the trim assembly. It must be ordered separately.

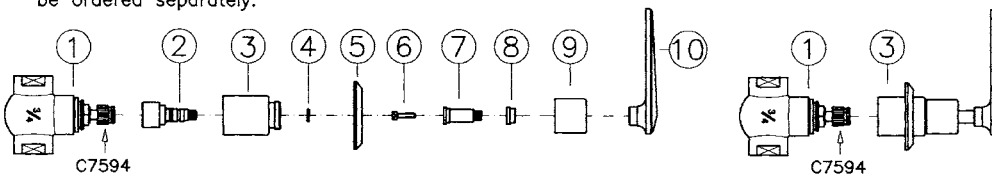

d - Before use

- Turn on the water supply to the faucet.
- Maximum temperature water supply to the faucet is 145° F.
- Maximum recommended pressure is 75 psi.

CHECK THE INSTALLATION CAREFULLY FOR LEAKS AFTER INSTALLATION.

If further building work is to be carried out in the vicinity of the faucet, it should be covered to prevent paint, adhesive, etc. from damaging the surface.

CARE AND MAINTENANCE

Spare Parts

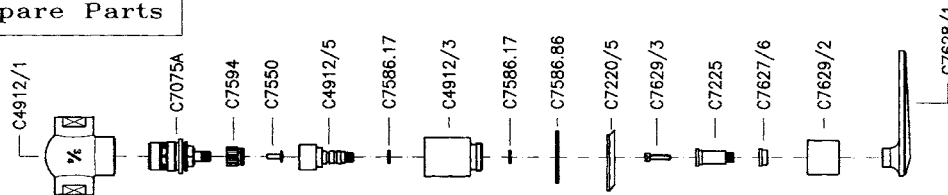

Care and use for finishes

Country Bath Products are all authentic finishes that have not been coated with any product.

After each use, pat the fixture down to remove any excess water. This will prevent any water spotting or mineral build-up. Use only soft liquid soap and water to clean the surface. Use a soft brush to clean any gaps. Avoid any products that have ammonia or alcohol like Windex, 409 or Fantastik. These products can damage the finish leaving black or white spots. Never use an abrasive product like Softscrub, Comet, Ajax or Bon Ami.

For deep polishing we recommend Bruno's Wax for all finishings.

Tuscan Brass is a living finish and has no warranty. It will lighten with use. To extend the life of the finish, apply Bruno's Wax by patting it on, letting it dry and patting it off. Never rub or buff this finish.

WARRANTY

Country Bath Collection has a limited lifetime warranty.

"Warranty Exclusion: This warranty is for normal domestic use only and excludes defect or injury caused by or resulting from misuse, abuse, neglect, accidental damage or improper installation". There is no warranty on the finish Tuscan Brass.

INSTALLATION INSTRUCTIONS

ROHL R1040R

Rough 3/4" Counterclockwise Opening
Concealed Wall Valve for Volume Control

INSTALLATION INSTRUCTIONS

*SUITABLE FOR PERRIN & ROWE, ROHL COUNTRY,
AND MICHAEL BERMAN SHOWER INSTALLATIONS

WORKS WITH THESE TRIM SETS:

Perrin & Rowe	Nicolazzi	Michael Berman
U.5542 U.5543	A4912	MB1951
U.5742 U.5743	A2912	
U.3240 U.3241	A4012	
U.3774 U.3775	A4212	
U.3604 U.3605		

ITEM NO	PART NUMBER	DESCRIPTION	QTY.
1	N/A	3/4 SHUTOFF TEE	1
2	R3-056	20 PT. BROACH STABILIZER	1
		20 POINT BROACH EXTENSION	1
		M24X1.0 ALL THREAD EXTENSION	1
3	9.15402	STEM ADAPTOR FOR PERRIN & ROWE	1
4	10215	STANDARD COUNTERCLOCKWISE CARTRIDGE	1
	10214	CLOCKWISE CARTRIDGE (SOLD SEPARATELY)	1
5	R30083	STEM ADAPTOR NICOLAZZI	1

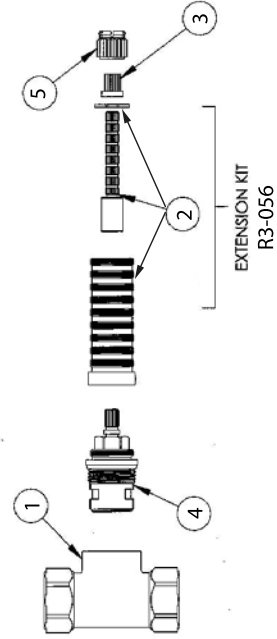

ROHL WARRANTY POLICY

- ROHL PRODUCTS ALL CARRY WARRANTIES AGAINST MANUFACTURING DEFECTS.
- THE R1040R VALVES CARRY A LIMITED LIFETIME WARRANTY.
- ROHL LLC WILL PROVIDE FREE OF CHARGE, AT ITS OPTIONS, REPLACEMENT PART(S) OR PRODUCT (OR A COMPARABLE ALTERNATIVE PRODUCT) TO REPLACE THOSE WHICH HAVE PROVEN DEFECTIVE IN MATERIALS OR WORKMANSHIP.

SPARE PARTS AND SERVICE:

ROHL
3 PARKER
IRVINE, CA 92618
P (714) 557-1933
F (714) 557-8635
WWW.ROHLHOME.COM

INSTALLATION INSTRUCTIONS

FINISHED WALL

Adaptors NOT needed if used for Michael Berman Volume Control

*Attention, Installer: There are two adaptors on the valve. Please reference trim set for correct adaptor.

NOTE: Valves must be installed according to direction of flow

REQUIRED MEASUREMENTS

A = 1 1/8" MIN.
B = ~5/16" (MUST LEAVE MIN. 3/4" EXPOSED OR TRIM WILL NOT FIT)
C = ~3/4" (MUST LEAVE MIN. 3/4" EXPOSED OR HANDLE WILL NOT ATTACH)

BEFORE USE:

- CAREFULLY CHECK THE INSTALLATION FOR LEAKS.
- IF FURTHER WORK IS GOING TO BE DONE IN THE VICINITY OF THE VALVE AND TRIM, COVER THE INSTALLATION WITH A PLASTIC BAG TO HELP AVOID DAMAGE TO THE FINISH.

CARE AND MAINTENANCE:

- RECOMMEND OCCASIONAL CLEANING WITH WARM SOAPY WATER FOLLOWED BY POLISHING WITH A SOFT CLOTH TO KEEP THE PLATED FINISH IN GOOD CONDITION.
- DO NOT USE ABRASIVE LIQUIDS, POWDERS, OR PADS TO CLEAN THE PRODUCT. YOU WILL DAMAGE THE FINISH AND VOID THE WARRANTY.

SPECIFICATIONS

TEMPERATURE RANGE:

- MINIMUM 34°F
- MAXIMUM 185°F

RECOMMENDED OPERATING PRESSURE:

- MINIMUM 15 PSI
- MAXIMUM 75 PSI

INSTALLATION NOTES

- MUST HAVE BOTH ROUGH AND TRIM TO COMPLETE THE INSTALLATION.
- FLUSH THE PLUMBING SYSTEM BEFORE INSTALLING THIS PRODUCT.
- MUST FOLLOW DIMENSIONS SUPPLIED FOR INSTALLATION AND MAKE SURE ALLOWANCE IS MADE FOR FINISHED WALL MATERIAL SUCH AS TILE, ETC.
- MUST INSURE THE HANDLE IS VERTICAL WHEN THE VALVE IS IN THE "OFF" POSITION.

NOTE: Lever should be in UP position for 'off' (Michael Berman trim shown).

IMPORTANT: WE RECOMMEND THE USE OF A LICENSED PLUMBER TO INSTALL THIS PRODUCT. PLEASE READ AND UNDERSTAND THE PROVIDED INSTALLATION INFORMATION BEFORE PROCEEDING.

INSTALLATION INSTRUCTIONS

ROHL[®] R1062BO

Rough 1/2" Quarter Turn Concealed
Wall Valve Three-Way Diverter

INSTALLATION INSTRUCTIONS

*SUITABLE FOR PERRIN & ROWE, ROHL COUNTRY,
AND MICHAEL BERMAN SHOWER INSTALLATIONS

WORKS WITH THESE TRIM SETS:

Perrin & Rowe	Nicolazzi	Michael Berman
U.5542 U.5543 A4912	A4912	MB1951
U.5742 U.5743 A2912	A2912	
U.3240 U.3241 A4012	A4012	
U.3774 U.3775 A4212	A4212	
U.3604 U.3605		

ITEM NO	PART NUMBER	DESCRIPTION	QTY.
1		3WAY BODY WITH 1/2"NPT	1
2	R3-056	20 POINT BROACH EXTENSION C-WASHER STABILIZER	1
3	10349	M24X1.0 THREAD EXTENSION NUT FOR CAP FOR 3WAY DIVERTER	1
4	10350	CARTRIDGE DIV MOTION 1/4 TURN WITH SHUTOFF	1
5	9.15402	STEM ADAPTOR PERRIN & ROWE	1
6	R30083	STEM ADAPTOR NICOLAZZI	1

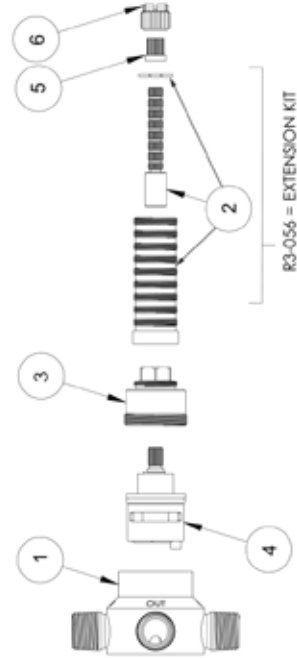

ROHL WARRANTY POLICY

- ROHL PRODUCTS ALL CARRY WARRANTIES AGAINST MANUFACTURING DEFECTS.
- THE R1062BO VALVES CARRY A LIMITED LIFETIME WARRANTY.
- ROHL LLC WILL PROVIDE FREE OF CHARGE, AT ITS OPTIONS, REPLACEMENT PART(S) OR PRODUCT (OR A COMPARABLE ALTERNATIVE PRODUCT) TO REPLACE THOSE WHICH HAVE PROVEN DEFECTIVE IN MATERIALS OR WORKMANSHIP.

SPARE PARTS AND SERVICE:

ROHL
3 PARKER
IRVINE, CA 92618
P (714) 557-1933
F (714) 557-8635
WWW.ROHLHOME.COM

INSTALLATION INSTRUCTIONS

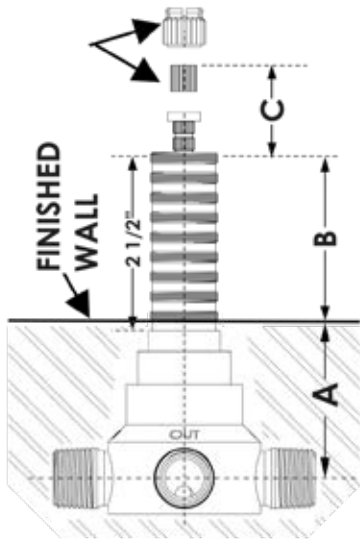

REQUIRED MEASUREMENTS

- A = 2-3/16" MIN.
- B = ~5/16" (MUST LEAVE MIN. 5/16" EXPOSED OR TRIM WILL NOT FIT)
- C = ~3/4" (MUST LEAVE MIN. 3/4" EXPOSED OR HANDLE WILL NOT ATTACH)

IMPORTANT:
WE RECOMMEND THE USE OF A LICENSED PLUMBER TO INSTALL THIS PRODUCT. PLEASE READ AND UNDERSTAND THE PROVIDED INSTALLATION INFORMATION BEFORE PROCEEDING.

BEFORE USE:

- CAREFULLY CHECK THE INSTALLATION FOR LEAKS.
- IF FURTHER WORK IS GOING TO BE DONE IN THE VICINITY OF THE VALVE AND TRIM, COVER THE INSTALLATION WITH A PLASTIC BAG TO HELP AVOID DAMAGE TO THE FINISH.

CARE AND MAINTENANCE:

- RECOMMEND OCCASIONAL CLEANING WITH WARM SOAPY WATER FOLLOWED BY POLISHING WITH A SOFT CLOTH TO KEEP THE PLATED FINISH IN GOOD CONDITION.
- DO NOT USE ABRASIVE LIQUIDS, POWDERS, OR PADS TO CLEAN THE PRODUCT. YOU WILL DAMAGE THE FINISH AND VOID THE WARRANTY.

SPECIFICATIONS

TEMPERATURE RANGE:

- MINIMUM 34°F
- MAXIMUM 185°F

RECOMMENDED OPERATING PRESSURE:

- MINIMUM 15 PSI
- MAXIMUM 75 PSI

INSTALLATION NOTES:

- MUST HAVE BOTH ROUGH AND TRIM TO COMPLETE THE INSTALLATION.
- FLUSH THE PLUMBING SYSTEM BEFORE INSTALLING THIS PRODUCT.
- MUST FOLLOW DIMENSIONS SUPPLIED FOR INSTALLATION AND MAKE SURE ALLOWANCE IS MADE FOR FINISHED WALL MATERIAL SUCH AS TILE, ETC.
- MUST USE WITH VOLUME CONTROL WHEN USED WITH THERMOSTATIC VALVE
- 1 X 1/2" M NPT INLET
- 3 X 1/2" M NPT OUTLETS
- FLOW IS DEDICATED
- MAY NOT BE SPLIT INTO TWO OUTLETS AT ONCE
- CALGREEN COMPLIANT
- 10 GPM
- OUTLETS MAY BE CAPPED IF NOT USED
- MIN. DEPTH IS 2 3/16" FROM MIDDLE OF THE VALVE OUTLET
- MAX. DEPTH IS 4 11/16" FROM MIDDLE OF VALVE OUTLET (CHECK DIMENSIONS)
- EXTENSION SOLUTION INCLUDED IN THE ROUGH PACKAGE. CUT BARREL AND EXTENSION TO SIZE AS NEEDED.
- ADDITIONAL EXTENSION KITS AVAILABLE.

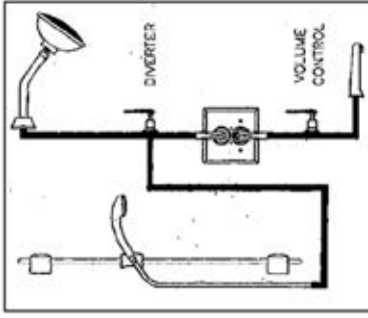

NOTE: Valves must be installed according to direction of flow

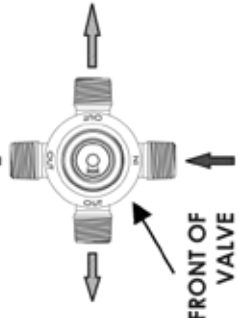

FRONT OF VALVE