



Palladian Pressure Balance Trim With Diverter

ROHL Transitional Palladian

A2900LM

FEATURES

- Palladian metal lever
- Single lever control
- Coverplate, dome, and handle made from solid brass
- Trim for concealed pressure balance shower and bath valve
- **To complete package order #RMV-2 rough valve**

COLORS/FINISHES

- Polished Chrome
- Polished Nickel
- Satin Nickel
- Tuscan Brass
- Inca Brass

WARRANTY

- Limited Lifetime*

* No Warranty on Tuscan Brass Finish

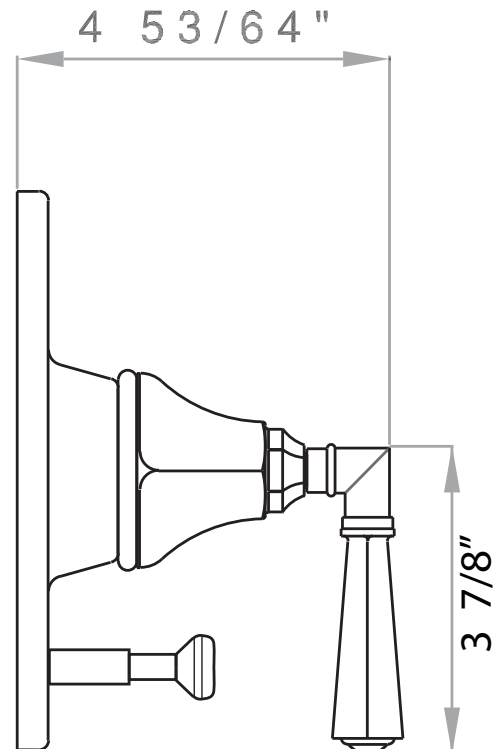
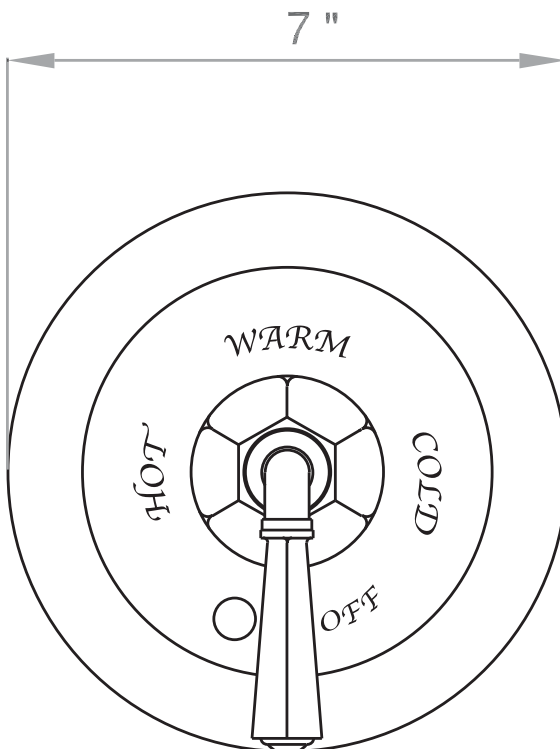

A2900 Spare Parts and Installation Instructions

IMPORTANT:

ROUGH AND TRIM MUST BE PURCHASED SEPARATELY. PLEASE NOTE THE HANDLE PIECES ARE ASSEMBLED IN THE BOX. YOU MUST DISASSEMBLE FOR INSTALLATION (SEE DRAWING).

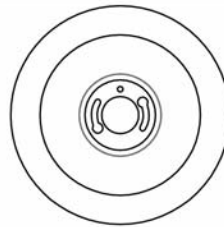

C7605/4 C7605/3 C7243/1 C7605

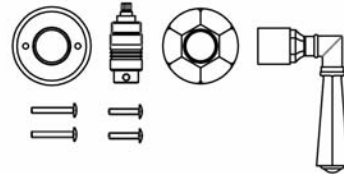

ASSEMBLING INSTRUCTIONS

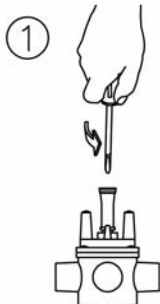

UNSCREW THE ADAPTER'S SCREW

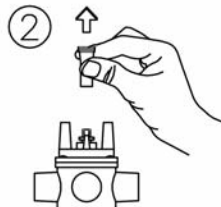

REMOVE THE ADAPTER, BUT LEAVE THE CAM STOP 1403-0696 IN PLACE (NOT PICTURED)

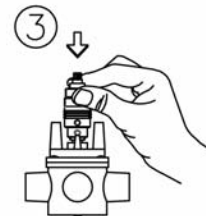

INSERT THE NEW ADAPTER FOR A7605 (PLEASE SEE UNDER THE "WALL LIMITS NOTE")

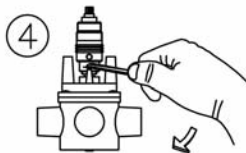

SCREW THE ADAPTER'S DOWEL TIGHTEN THE ADAPTER ONTO THE SPINDLE WITH A 3 mm. ALLEN KEY (NOT INCLUDED)

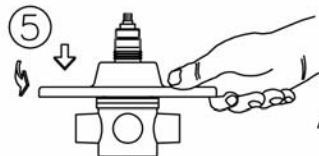

PLACE THE EXTERNAL PLATE PLEASE NOTE, THE ADAPTER HAS A VARIABLE LENGTH TO ADJUST FOR THE VALVE DEPTH. FIT THE PLATE, AND SCREW THE ADAPTER OUT TO EXPOSE THE 3 O-RINGS. ADJUST THE DEPTH AS NEEDED; THEN TIGHTEN WITH 3mm. ALLEN KEY

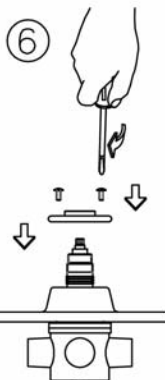

PLACE THE ADAPTER'S RING AND FIX IT WITH THE SCREWS



SCREW THE HEXAGONAL CAP HAVING CARE TO UNSCREW 1/4 TURN TO THE END

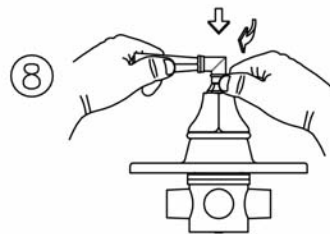

INSERT THE HANDLE AND FIX IT SCREWING THE HEXAGONAL COVER VALVE ATTENTION: BE SURE THAT THE HANDLE HAS NO PLAY UNSCREW THE CAP JUST TO GET IN TOUCH WITH THE COVER VALVE

WALL LIMITS NOTE

FINISHED WALL LIMITS (TEMPRESS TEMPLATE INDICATION)

MINIMUM

MAXIMUM

ADJUSTING THE ADAPTER LENGTH

UNSCREW THE DOWEL EXTRACT THE LOWER PART SCREW THE DOWEL

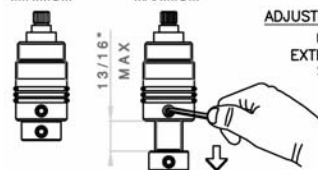

ATTENTION : ENSURE ALL PARTS ARE FIRMLY TIGHTENED